

## Controlled Navigation Worksheets

### Introductory Problem

Below is an image of an unrestricted navigation in which all routes cost the same. Here, assume that if a value is not written, the value is 1 to travel from one grid point to another.

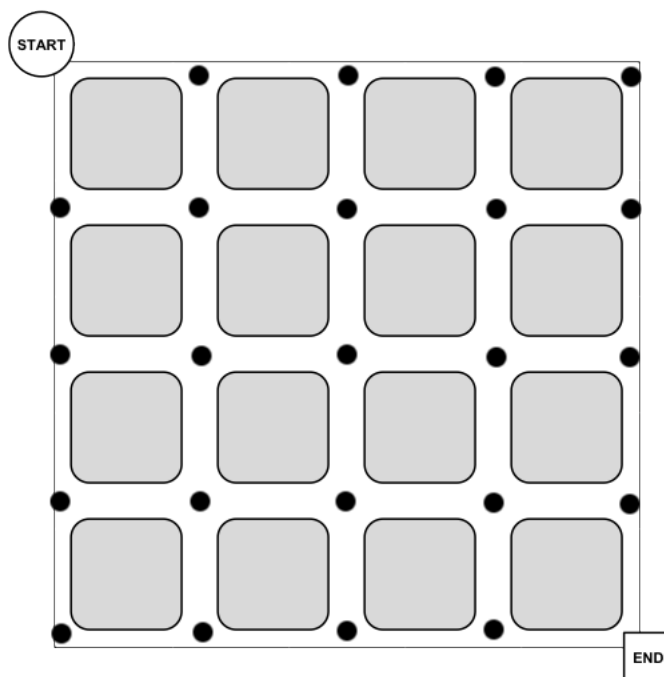



With the above problem and each subsequent problem,

1. Is there a path that leads from the start to finish?
2. Is it the only path?
3. If there are multiple paths, is one the best path?
4. What is the value of the “best” path?
5. (Challenge) Can you prove which path is the “best”?

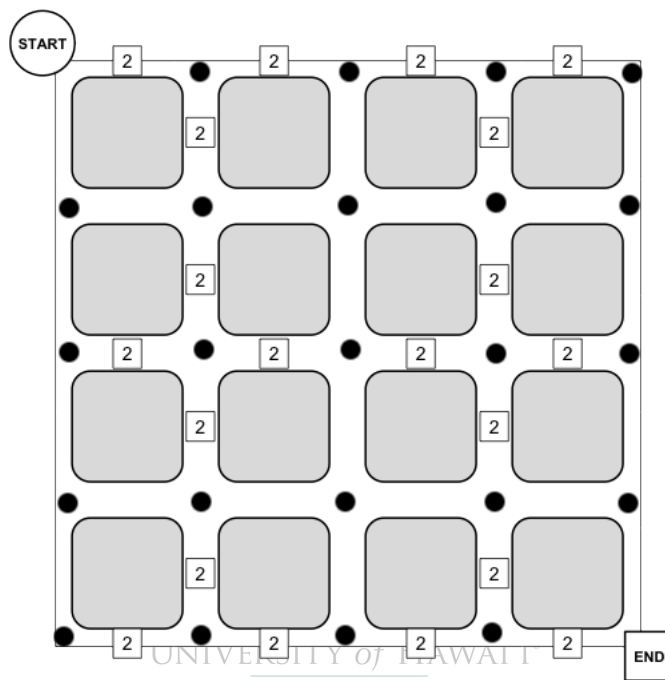
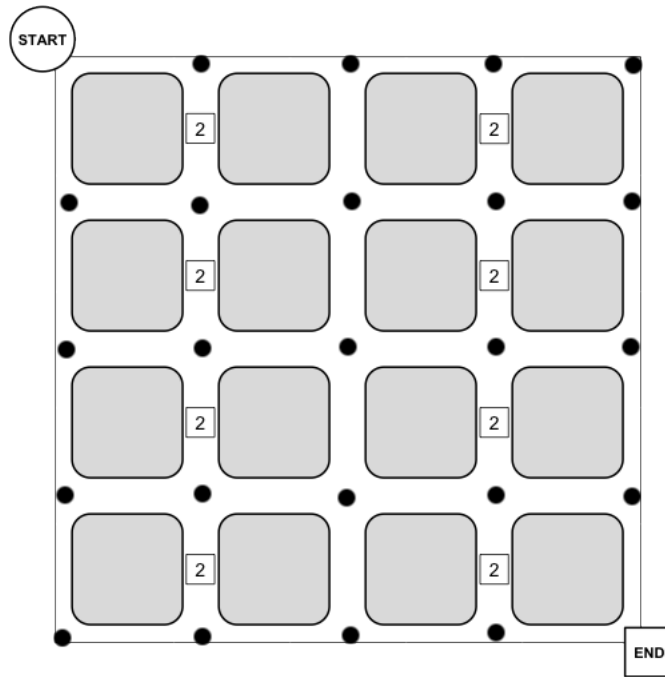

DEPARTMENT OF MATHEMATICS



UNIVERSITY OF HAWAII  
MĀNOA  
  
DEPARTMENT OF MATHEMATICS

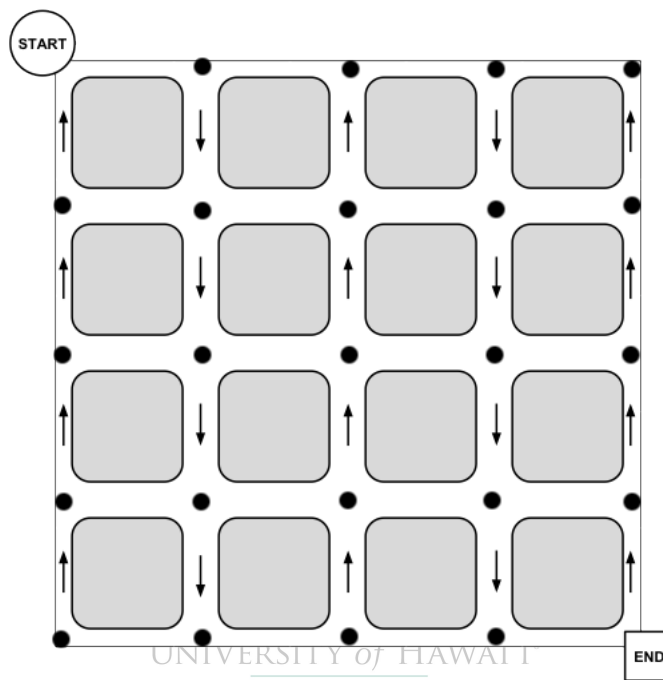
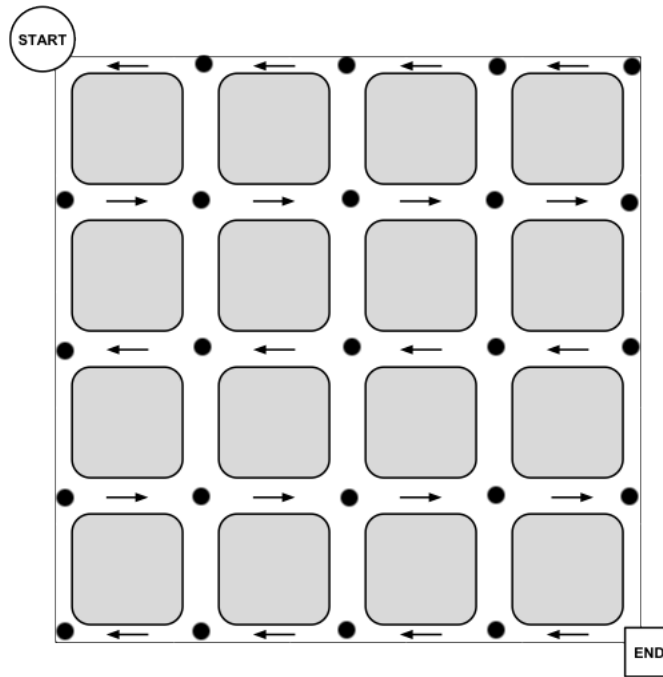

UNIVERSITY OF HAWAII  
MĀNOA



DEPARTMENT OF MATHEMATICS

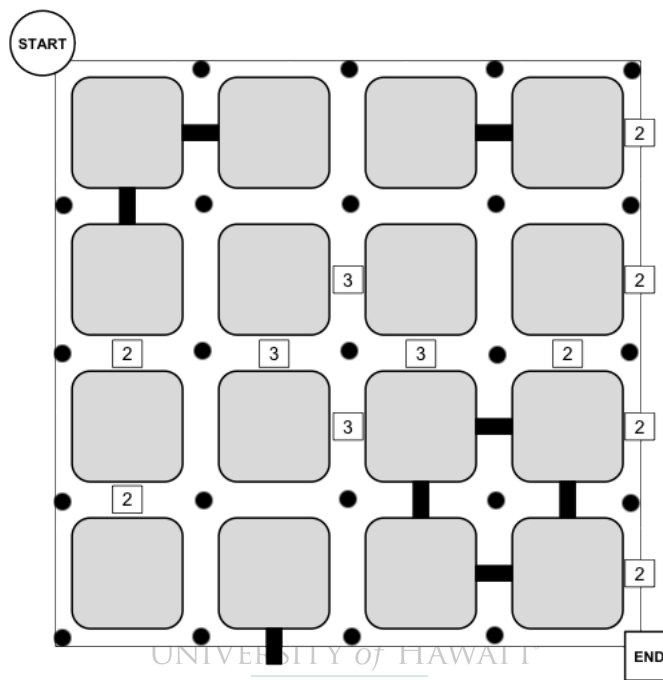
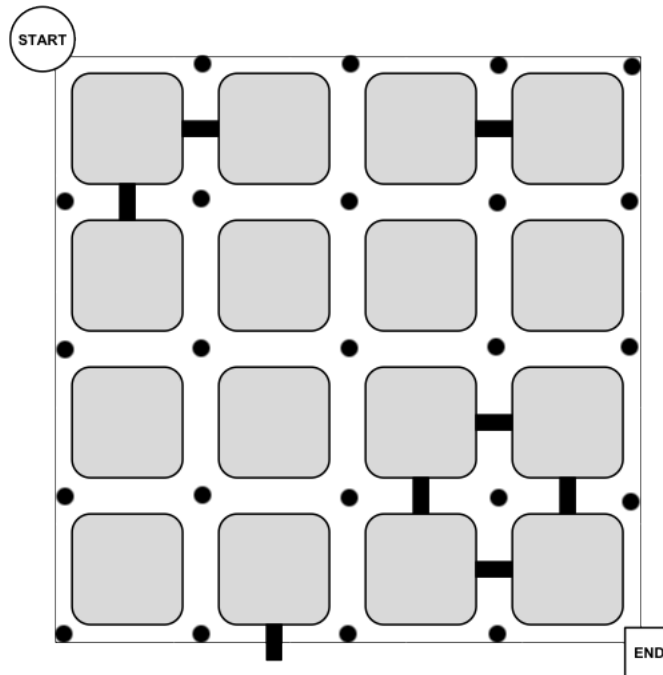

UNIVERSITY OF HAWAII  
 MĀNOA



DEPARTMENT OF MATHEMATICS

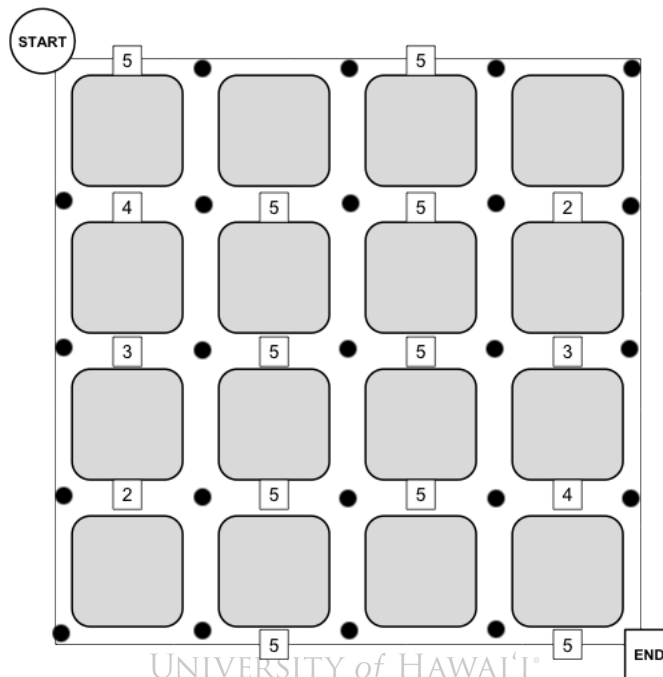
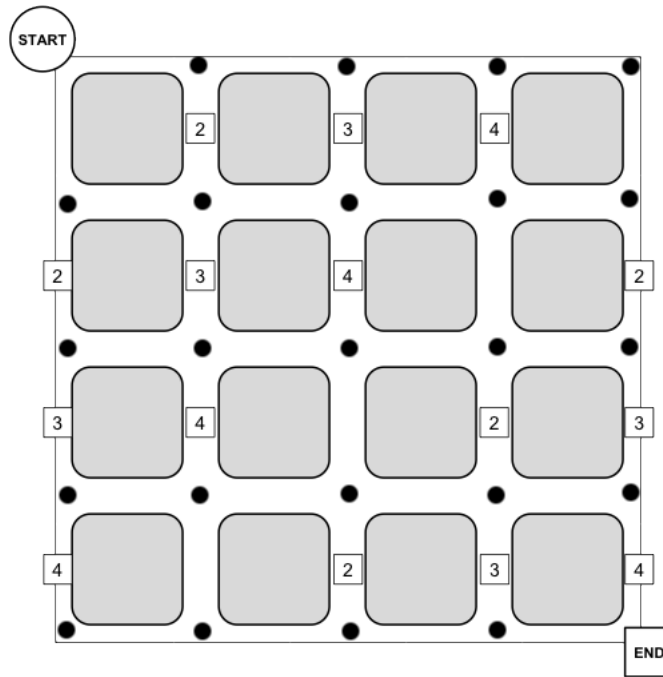

UNIVERSITY of HAWAI'I  
 MĀNOA



DEPARTMENT OF MATHEMATICS